



LEADER LIGHT s.r.o.  
M.Gorkeho 33  
052 01 Spisska Nova Ves  
Slovakia  
www.leaderlight.eu

# LEADER LIGHT

## USER MANUAL

### LL STAGE 6-06D

LL36 080



#### COMPLIMENTS ON YOUR PURCHASE!

All dimensions are in millimeters

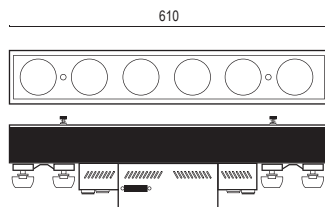

#### Package includes:

- LL STAGE 6-06D with adjustable bracket
- PowerCon type "A" + "B"
- User manual

1pc.  
1pc.  
1pc.

#### Additional items needed:

- Data cables with XLR 5pin F/M
- Controller compatible with DMX
- Mounting accessories as necessary

1pc.  
1pc.

#### Content:

#### 01 SAFETY INFORMATION

- 01.1 Risk of eyes damage
- 01.2 Safety instructions
- 01.3 Fire protection

#### 02 PRODUCT SPECIFICATION

- 02.1 Technical specification
- 02.2 Product description

#### 03 INSTALLATION

- 03.1 Unpacking
- 03.2 Physical installation
- 03.3 Connection
- 03.4 Control data connection
- 03.5 DMX channels

#### 04 MAINTENANCE AND SERVICE

#### ENVIRONMENTAL PROTECTION

Do not throw away the appliance with the normal household waste at the end of its life, but hand it in at an official collection point for recycling. By doing this, you help to preserve the environment.



## 01 SAFETY INFORMATION



### WARNING!!!

Carefully read before installing, powering or servicing. Nothing to do if anything misunderstand! Installation can be done only by a qualified professional in accordance with relevant local codes.

### 01.1 Risk of eyes damage

- Do not look directly into LED lamps.
- Do not look into light beam from a distance of less than 40 cm (16 inches)!



### 01.2 Safety instructions

- Shut down power before installation or maintenance.
- Do not modify, alter, or attempt to service the LEADER LIGHT appliance. Doing so will void the warranty.
- Appliance and recommended AC power supply must be installed by a qualified professional in accordance with relevant local codes. Use only acceptable source of AC power and frequency that complies with local building and electrical codes.
- Use only the recommended voltage source.
- Appliance always connect to earth (eltech.)!
- Do not use or do not connect the products if the power cable, power plug or fixtures are any way damaged, wet, or if they are overheating.
- Before removing or installing any cover or part of appliance disconnect it from AC power.
- AC power supply must be protected against overvoltage and short circuits.



### 01.3 Fire protection

- Follow all safety restrictions.
- Thermostatic switches or fuses never to bypass.
- Device never shield. Around the axis of the fitting (180°) must be maintained space for cooling. Minimum distance from the surrounding objects must be 100mm (4 in.).
- LEDs never direct cover with filters or other materials.
- Allowing max. ambient temperature is 40°C (104°F).
- Luminaries never use without mounting brackets. The housing never install directly to the surface.



Non-minimum distance and / or non-use the original brackets is at your own risk!

## 02 PRODUCT SPECIFICATION

### 02.1 Technical specification

**Power connection:** 100-260V AC 50-60Hz In/Out PowerCon

**IP:** IP20

**Control data:** DMX 512 In/Out with XLR 5pin

**Ambient temp. (Ta):** Maximum 40°C

**Net weight:** 6kg

**Installation:** Surface mounting

## 02.2 Product description

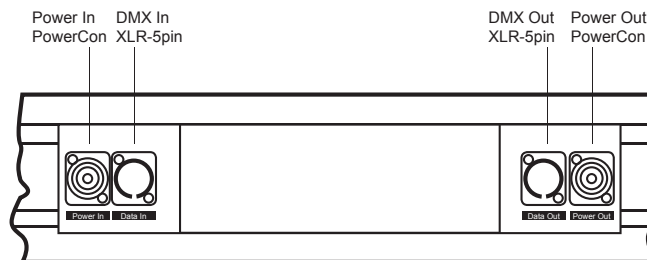

### Indication of control LEDs (LED power- green, LED data - yellow)

LED	Indication	Status
LED Power	blinking - 2Hz	O.K. - Device is working correct
LED Data	not lit	No DMX signal
LED Data	blinking - 4Hz	O.K. - Correct DMX signal
LED Data	fast blinking	ERROR - Incorrect digital signal
LED Power & LED Data	alternating blinking	function AutoTest

## 03 INSTALLATION

### 03.1 Unpacking

- Unpack carefully.
- This is electronic equipment and should be handled carefully.
- Damaged delivered package or if are any mechanical parts broken – it must be claim immediately by the transport company. Photo pictures as evidence are valuable for future claim.

### 03.2 Physical installation

- Loading capacity of bearing area has to be at least 10 times the weight of all device clusters.
- Hairbreadth from combustible materials is 0,5m.
- Before physical installation insert the optic modul on front of luminary. The optic installation is easy and fast by 2 screws. (figures Nr. 2.1 to 2.2)

### 03.3 Connection

- Respect all SAFETY INFORMATION 01!
- Connect the ground (earth) !
- It is not necessary to open the fixture before power supply. Power supply is solved simple with Neutrik PowerCon connectors.
- The fixture is equipped with auto-switching power supply that automatically adjusts to any 50-60Hz AC power source from 100-260V.



- Cord plug connections:

Symbol	Pin	Wire Colour	Screw (US)
L	live	brown	yellow or brass
N	neutral	blue	silver
⏚	ground (earth)	yellow/green	green

### 03.4 Control data connection

- Control data cable length is specified by Norm IEC929 Annex E4.
- It is not necessary to open the fixture before connecting of DMX512 control signal. Interconnections are realized by Neutrik XLR 5pin In/Out connectors.
- Pin connections:
  - Pin 1 – ground
  - Pin 2 – signal negative
  - Pin 3 – signal positive

### 03.5 DMX channels

*These informations are subject to change. latest data are on: [www.leaderlight.eu](http://www.leaderlight.eu)*

#### Functions Dip1-Dip4:

- Dip2=Off, Dip3=Off: Mode1: 6ch(W1,W2,W3,W4,W5,W6) +2ch(Master,Strobo)
  - Dip2=Off, Dip3=On: Mode2: 1ch(W1+W2+W3+W4+W5+W6) +2ch(Master,Strobo)
  - Dip2=On, Dip3=Off: Mode3: 2ch(W1+W3+W5, W2+W4+W6) +2ch(Master,Strobo)
  - Dip2=On, Dip3=On: Mode4: 3ch(W1+W2, W3+W4, W5+W6) +2ch(Master,Strobo)
- Dip1=on enable add+2ch (Master+Strobo)

- Dip4=Off - standard curve
- Dip4=On - ultrasoft curve

#### Functions DipBCD:

- 9xx - AutoTest - gradual fade-over by the Mode
- 8xx - AutoTest - On W1+W4
- 7xx - AutoTest - On W2+W5
- 6xx - AutoTest - On W3+W6
- 5xx - AutoTest- On all



LL36 330

Order Code	Product name	Optic (°)
LL36 080.1	LL STAGE 6-06D W (delivery with LL BEAM FRAME STAGE6)	1°
Accessories		
Order Code	Product name	
LL37 200.1	LL BEAM FRAME STAGE 6-06 (1°)	
LL37 220.1	LL FRAME STAGE 6-06 SQ6 MILKY	
LL37 230.1	LL FRAME STAGE 6-06 R6 MILKY	
LL37 232.1	LL FRAME STAGE 6-06 R6 CLEAR (120°)	
LL36 300.1	LL BRACKET STAGE 6 SERIAL	
LL36 320.1	LL BRACKET STAGE 6 PARALLEL DUAL (2pcs)	
LL36 330.1	LL BRACKET STAGE 6 FIX	
LL36 340.1	LL BRACKET STAGE 6 ADJUSTABLE	
LL36 345.1	LL BRACKET STAGE 6 MATRIX 6x6	
LL90 000	W-DMX MODUL 2,45GHz/5,8GHz DMX/RDM supply with W-DMX antenna	

### Mechanical mounting of LL STAGE 6-06D

Mounting on stage is easy using various accessories as seen below (Figures Nr. 1.1 to 1.2). The brackets are connect by Camlocs.



- Camloc 1/4 turn fasteners**
- Safe mechanical quick release fastener systems
  - Locking/unlocking by quarter turn
  - Hand operated
  - Service-friendly, time-saving and cost cutting
  - Vibration-resistant

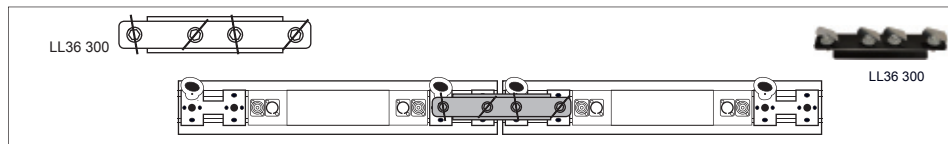

1.1 Serial connection by LL36 300 for creation of continuous line

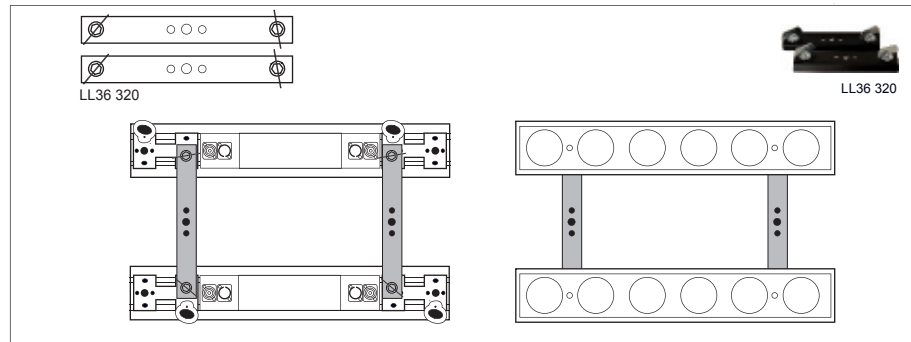

1.2 Parallel connection by dual bracket LL36 320



**AIMING POSSIBILITY**  
The fixture could be aim to wish position with adjustable bracket.

### Mechanical mounting of frame to the LL STAGE 6-06D

Frame installation without tools (Figures Nr. 2.1 to 2.2).

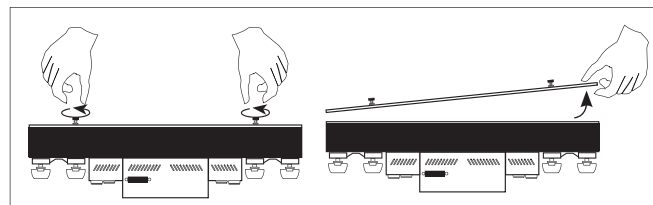

2.1 The screws unlock by hand. Pick out the frame.

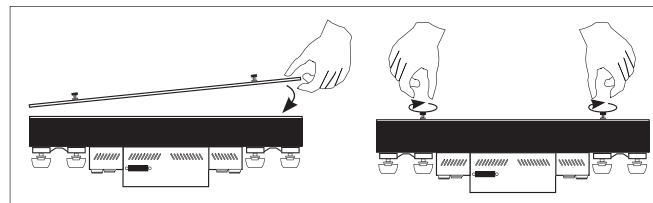

2.2 Insert the new frame. Apply the screws by hand.

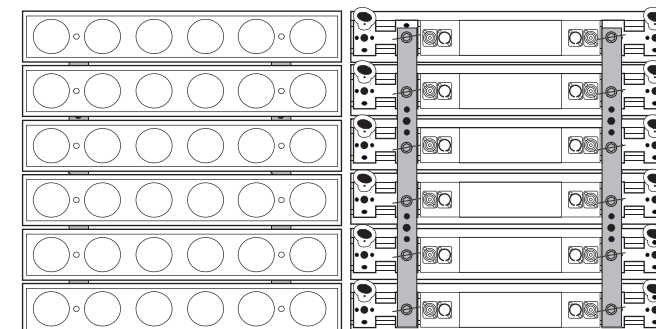
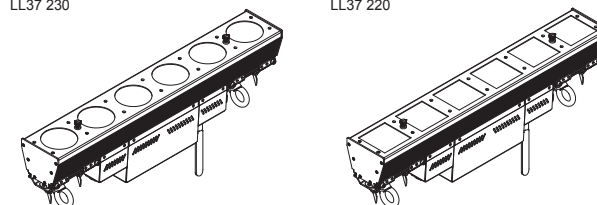
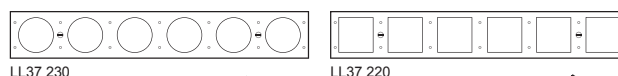

Mounting with LL BRACKET STAGE 6 MATRIX 6x6

### 04 MAINTENANCE AND SERVICE

- Before any maintenance is necessary to carefully read all **SAFETY INFORMATION 01!**
- Damages caused by inadequate cleaning or maintenance are not covered by warranty.
- Requires periodic cleaning (dust, dirt ,...)

#### Procedure for maintenance:

- Unplug mains before maintenance and at least 10 minutes cool off.
- Appliance do not illegal open or demount.
- Clean-up dust only from outer surface. Use vacuum or dumpy duster (warm water)
- Before reinstalling make sure everything is intact and dry– no wet parts!

#### Service:

- Customer service provided by the manufacturer.

